

Varenummer: 2031100M2075B1T
 Beskrivelse: E+G Justerfod
 GN 31-100-M20-75-B1-T
 Note: T Uden møtrik, spændeflade i bunden

Mål

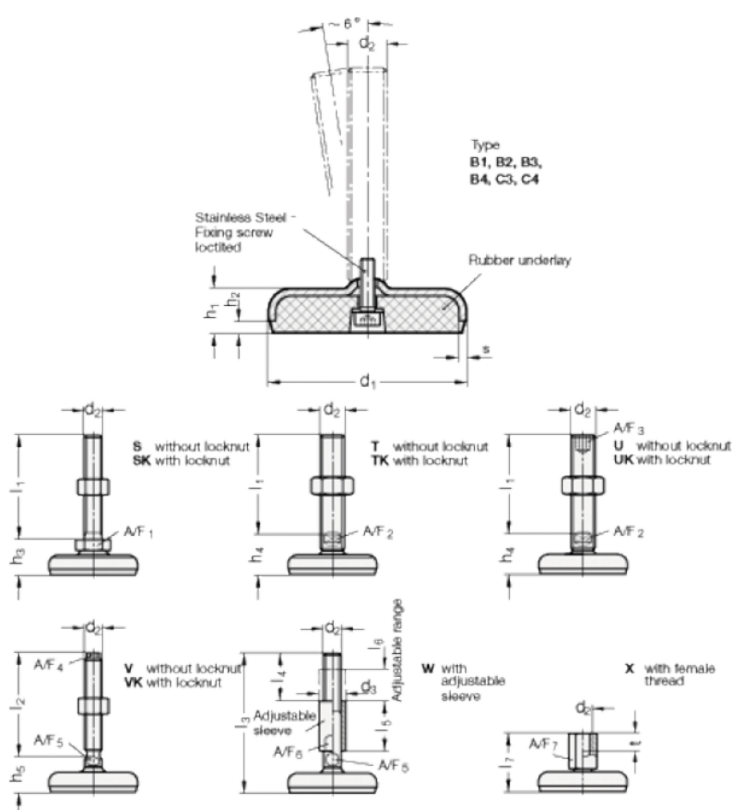

A/F2	= 15
d1	= 100
d2	= 20
h1	= 20
h2	= 6
h4 +4.0/0	= 35
l1	= 75
s	= 3